

CUSTOMER REFERENCE DRAWING

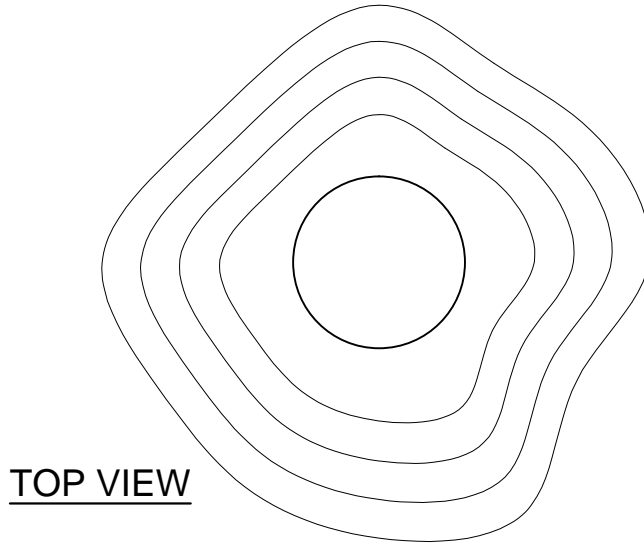

TOP VIEW

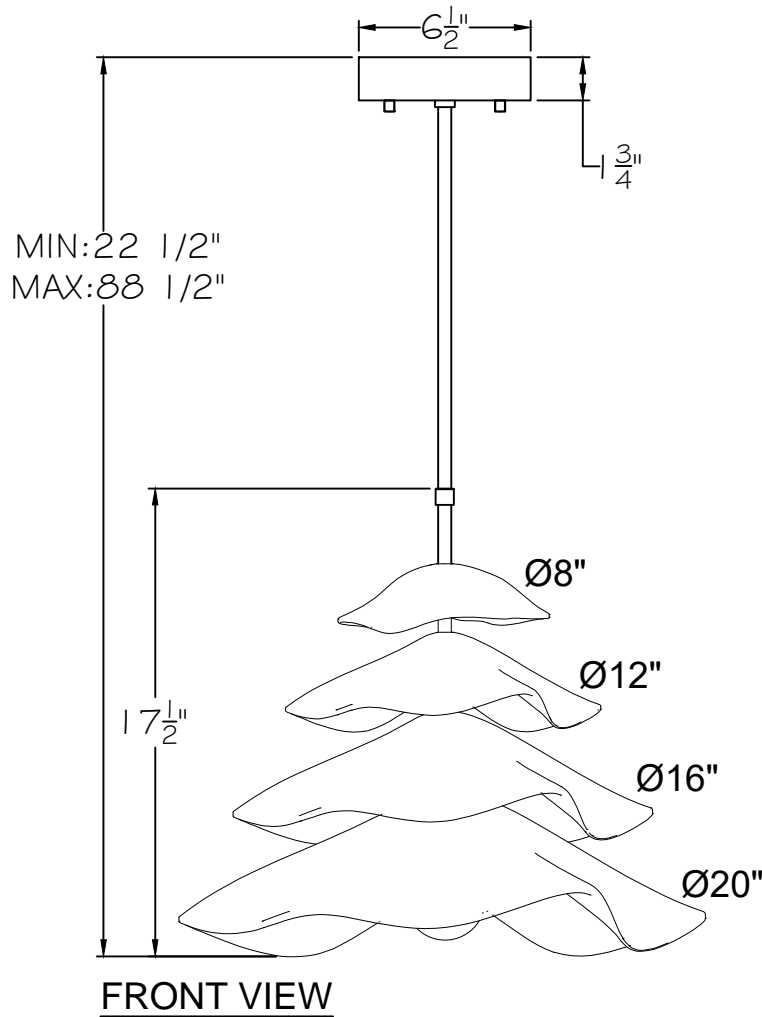

FRONT VIEW

STYLE 12-
 BODY FINISH
 GLASS

STYLE CONFIGURATIONS:

-3 _ (GOLD LEAF)	-4 _ (SILVER LEAF)	-5 _ (WHITE)				
-_1 (BLUE GLASS)	-_2 (AMBER GLASS)	-_3 (CLEAR GLASS)				



This drawing, specifications and the product depicted are the exclusive property of Fine Art Handcrafted Lighting®. In compliance with US copyright and patent requirements, notice is hereby given that this document and the product depicted shall not be copied, altered or used in any manner without the expressed written consent of Fine Art Handcrafted Lighting®.

www.finearthl.com Tel:(305) 821-3850
 FINE ART LAMPS®

STYLE NUMBER: 100061
DATE: 7/11/24